

MoTeC

M142 TOYOTA YARIS GR 2020 KIT



This M142 Plug-In Kit provides a complete replacement for the OE (original equipment) ECU for the Toyota Yaris GR 2020. Using existing wiring, the original fuel system and sensors, it delivers convenient installation with fully programmable control.

Along with fuel, ignition, throttle and camshaft control, this Kit also supports other OE ECU features, including:

- **Selectable Drive Mode including Normal, Sport, and Track using OE controls**
- **Head-Up Display**
- **Direct injector with high pressure fuel pump control and secondary port injector control (saturated high-ohm injectors only)**
- **Cruise control**
- **All OE dash functionality including warnings**



Drivers should be aware that specifically the following standard features do not work utilising this M1 Package: Active Cruise Control, Dynamic Stability Control, Low Speed Pre-Collision System and Lane Trace Assist.

This product does not interact with the Radar Collision subsystem on the vehicle. As a result continuous alerts may be visible in the dash central information display and the following dash lights may be illuminated:

 DSC (Dynamic Stability Control) Warning

 Low Speed Pre-collision System Indicator

Installing the optional Dash Override feature prevents alarms associated with these systems showing up on the dash.

▶ VEHICLE COMPATIBILITY

This product includes CAN messaging for full OE vehicle integration. The Package caters for OE vehicle systems such as power steering, ABS, starting systems and dashboards.

The following table shows compatible vehicles.

Vehicle	Year	Badge	Comment
Toyota Yaris GR	2020	GR	Engine G16E-GTS

▶ KIT CONTENTS

- **13142M** - M142 ECU MARINE
- **61459** - M142 TOYOTA YARIS GR 2020 ADAPTOR KIT
 - **61460** - M142 TOYOTA YARIS GR 2020 ADAPTOR BOX
 - **61404** - M1 ADAPTOR 250MM 26W KEY 1 STUB LOOM
 - **61405** - M1 ADAPTOR 250MM 26W KEY 3 STUB LOOM
 - **61406** - M1 ADAPTOR 250MM 34W KEY 1 STUB LOOM
 - **61407** - M1 ADAPTOR 250MM 34W KEY 2 STUB LOOM
 - **57006** - BOSCH LSU 4.9 WIDEBAND LAMBDA SENSOR
 - **61430** - M1 ADAPTOR LTC LOOM
 - **61300** - LTC - LSU LAMBDA TO CAN
 - **61461** - TOYOTA YARIS GR 2020 GATEWAY LOOM
 - **68050** - 2 PIN DTM CONNECTOR KIT MALE
 - **68051** - 2 PIN DTM CONNECTOR KIT FEMALE

Licence

- **23578** – M1 LICENCE - TOYOTA YARIS GR 2020

This Licence is required to run the M142 TOYOTA YARIS GR 2020 Package in the M142 ECU.

▶ FEATURES

- This kit fully integrates with these original systems:
 - Direct fuel injection
 - Starting systems
 - Dashboard
 - Drive Mode
 - Differential
 - Electric Power Steering
- For ease of integration a number of features are pre-configured to suit compatible vehicles:
 - Sensor calibrations for Original Equipment (OE) sensors and engine triggers.
 - Control of primary (Direct Injector) and Secondary (port injector) fuel system.
 - Reference mode for engine synchronisation.
 - Physical settings for engine displacement, fuel density, stoichiometric ratio, fuel pressure, and injector linearisation, for simplified engine start-up prior to tuning.
 - CAN messaging for OE systems including dashboard and differential.
 - Boost control with wastegate actuator.
 - Transient fuelling compensation using physical modelling of fuel film for direct injectors.
 - On-board knock control for each cylinder using the OE knock sensors and selectable centre frequency.
 - Lambda control is supported with included LTC and Bosch LSU4.9 sensor.
 - Idle closed loop control system using ignition and throttle servo actuation.
 - Sensing of OE subsystems
 - Engine Oil Temperature and Pressure
 - Coolant Temperature
 - Boost Pressure
 - Fuel Pressure Direct and Fuel Pressure (low)
 - Transmission Temperature
 - Steering Angle, Vehicle Acceleration and Wheel Speeds
 - Airbox Mass Flow
 - Intake Manifold Pressure and Temperature
 - Clutch Position
 - Throttle Servo and Pedal Position
 - Gear Input Shaft Speed
 - Clutch
 - Brake (x2)
 - Reverse
 - Neutral
 - iMT (Downshift Blip)
 - Cruise switches
 - Control of OE subsystems:
 - Cooling Fan control
 - Airbox Flap
 - Fuel Purge Solenoid
 - Turbocharge Bypass (blowoff) Valve
 - Downshift rev matching
 - Alternator (LIN)
 - Engine Load Average channel with tables for engine speed limit, ignition timing trim, fuel mixture aim, boost limit, and throttle limit.
- Configurable features:
 - Configurable security for multiple users with differing access options.
 - Intercooler temperature and spray control.
- Included GPR features:
 - Lap distance, time and number via BR2 or switched input, with split and sector options.
 - Vehicle speed limiting (pit speed control).
 - Launch control
 - Race time system with tables for ignition timing trim, fuel mixture aim, boost limit, and throttle limit.
 - Configurable anti-lag with ignition timing limit, fuel volume trim, ignition cut, fuel cut, engine speed limit, boost aim and throttle aim tables.
 - Traction control with tables for aim main, aim compensation, control range
- Additional optional integrations:
 - Support of MoTeC devices: E8XX, PDM, SLM, Keypad, Rotary Controller.
 - 8 configurable driver switches, 8 rotary switches and MoTeC Keypad and Rotary Controller support, each with 10 positions that can be simultaneously mapped to launch control, pit switch, anti-lag, traction, race time reset, engine speed limit maximum, throttle lever translation, fuel volume trim, ignition timing, fuel mixture aim, boost limit, traction aim, and traction control range.
 - GPS acquisition and logging via CAN or RS232.
 - ECU CAN Receive from a defined ID base address for data reception from MoTeC devices.
 - Coolant pump output with PWM control.
 - Coolant pump after-run functionality, optionally with additional pump output.
 - Switchable inlet manifold runner with position feedback.
 - Engine run time total for engine hour logging.
 - Pulsed tachometer output with configurable output pin and scaling.
 - Transmission pump output with transmission temperature threshold and hysteresis control.

- Optional channels for additional sensors via input pin and/or CAN message, including:
 - Ambient Temperature
 - Brake Pressure
 - Coolant Pressure
 - Engine Crankcase Pressure
 - Exhaust Pressure
 - Temperature
 - Intercooler Temperature
 - Turbocharger Speed
 - Brake Pressure and Position
 - Coolant Pressure
 - Differential Temperature
 - Engine Crankcase Pressure
 - Exhaust Pressure and Temperature
 - Fuel Composition, Flow and Temperature
 - Transmission Pressure

▶ OPERATION

Reference Mode

The M1 Reference Mode in this Package is locked to the Toyota Yaris GR pattern.

ECU Power

The M1 ECU will be powered as follows:

- When the push start button is pushed once.
- When the M1 is connected to the M1 Tune application via Ethernet. Once on, power will remain when the M1 is connected to the M1 Tune application via Ethernet.

Engine Start

This feature operates identically to OE behaviour.

Driver Switches

Various in-car dials and switches are acquired over the CAN bus and assigned to Firmware resources to allow for mode switching in the ECU. See the Help for the main Toyota Yaris group in M1 Tune.

Fuel Pressure Control - (Lift Pump)

The vehicle uses a PWM controlled low pressure fuel pump (lift pump) which operates in closed loop. Desired fuel pressure is set in the Fuel Pressure Control Aim table.

Dash Override

If installed, the optional Dash Override feature can be enabled.

 This feature can be enabled by holding down the **Drive Mode Normal Switch** for 5 seconds. This will cause the Secondary Brake Collision System, Pre-Collision Malfunction and Lane Trace Assist warning messages as well as the Dynamic Stability Control and Low Speed Pre-Collision System malfunction indicator lights to be hidden from the OE Dash.

 Enabling this feature removes dash warning lights designed to alert the driver of malfunctioning Active Cruise Control, Dynamic Stability Control, Low Speed Pre-Collision System and Lane Trace Assist.

▶ INSTALLATION

This procedure details installation of this Kit into a Toyota GR Yaris 2020.

Kit Components

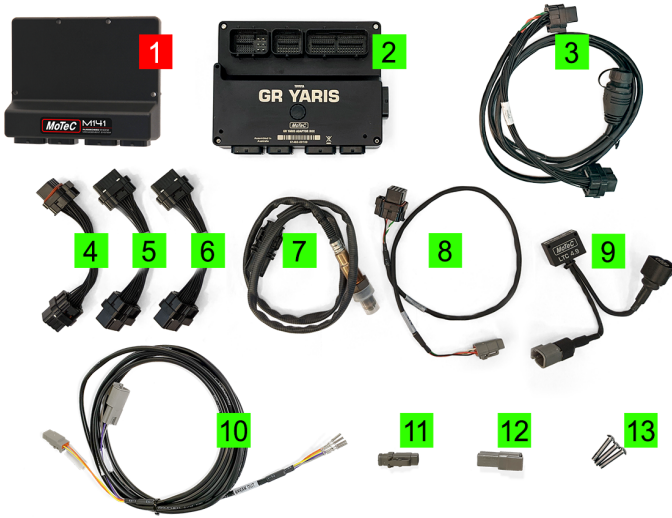

1. M142 ECU MARINE
2. M142 TOYOTA YARIS GR 2020 ADAPTOR BOX
3. M1 ADAPTOR 250MM 26W KEY 1 STUB LOOM
4. M1 ADAPTOR 250MM 26W KEY 3 STUB LOOM
5. M1 ADAPTOR 250MM 34W KEY 1 STUB LOOM
6. M1 ADAPTOR 250MM 34W KEY 2 STUB LOOM
7. BOSCH LSU 4.9 WIDEBAND LAMBDA SENSOR
8. M1 ADAPTOR LTC LOOM
9. LTC - LSU LAMBDA TO CAN
10. TOYOTA YARIS GR 2020 GATEWAY LOOM
11. 2 PIN DTM CONNECTOR KIT MALE
12. 2 PIN DTM CONNECTOR KIT FEMALE
13. M5 fasteners x 3 (included with Adaptor Box)
14. M5 flat washer (not shown, included with Adaptor Box)

Tools Required

- Small flat blade screwdriver
- Side cutters
- 8 mm socket
- 10 mm socket
- 12 inch 3/8 socket extension
- Socket for Lambda sensor
- 3/8 universal joint
- 3/8 ratchet
- Needle nose pliers

Step 1: Remove Peripherals

- With the key off and the vehicle parked in a suitable location in which to work, pop the bonnet and remove the engine cover.



- Unlatch airbox clips, and loosen circled hose clamp.
- Unclip the rubber hose that passes over the rubber intake tube.

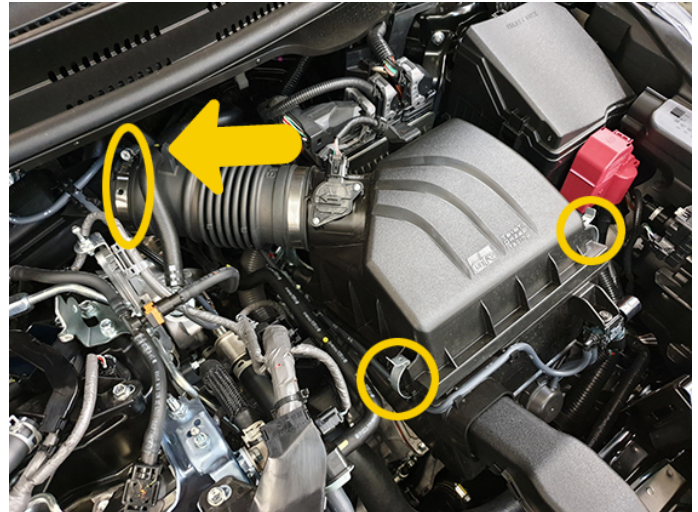

- Unplug mass airflow sensor

- Unclip the wiring support bracket from the airbox lid

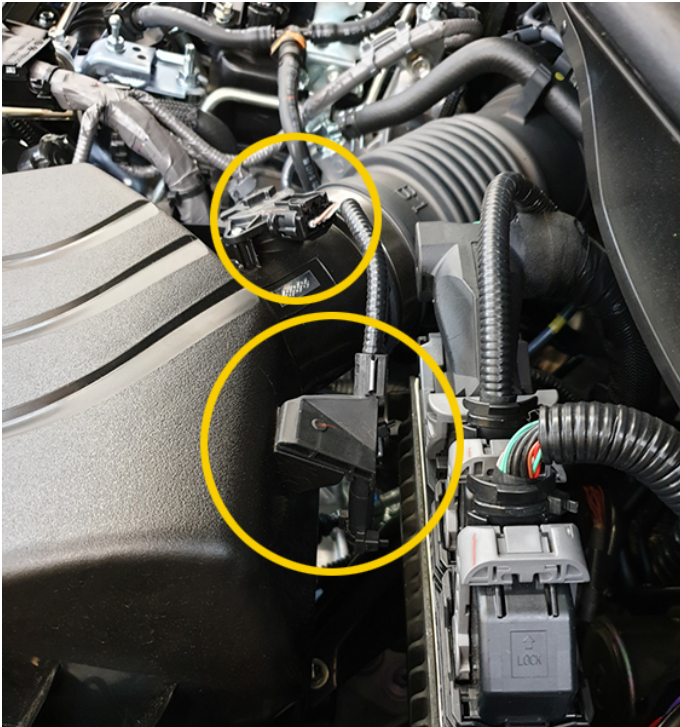

- With the mass airflow meter tucked out of the way, remove the airbox lid and rubber intake tube as a single assembly:
 - (1) First raise the front edge of the box up, and pull the airbox lid forward slightly to unlatch it.
 - (2) Wiggle the rubber intake pipe off the plastic inlet assembly.
 - Remove the assembly from the engine bay, and put it off to the side.
 - It is recommended to remove the air filter from the lower airbox portion to prevent damage while changing the ECUs over.

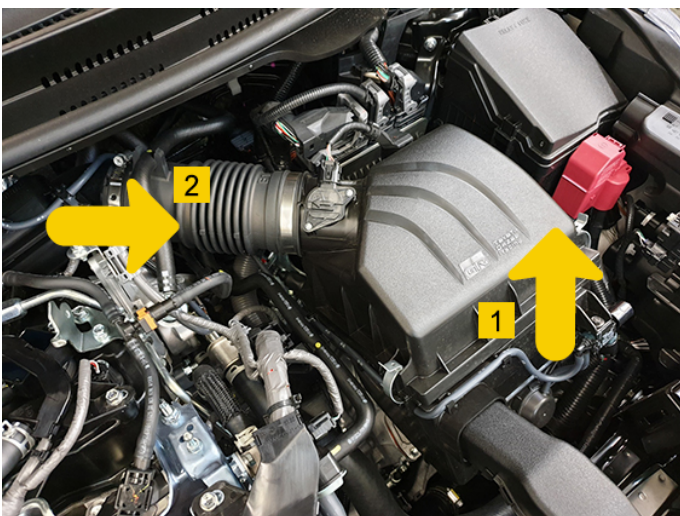

Step 2: Remove the Yaris ECU

- Using the small flat blade screwdriver or a pair of pliers, unclip the mass airflow wiring from the silver bracket.

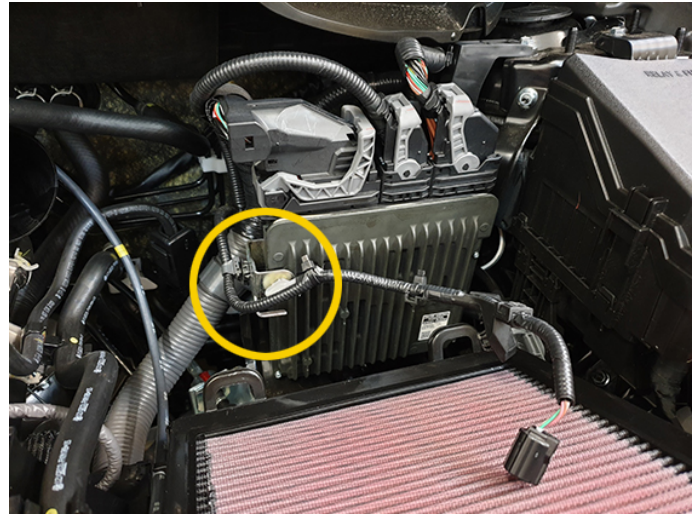

- Unplug the ECU connectors in the order as numbered. They are removed by pressing down the locking tab, and then moving the light grey levers.

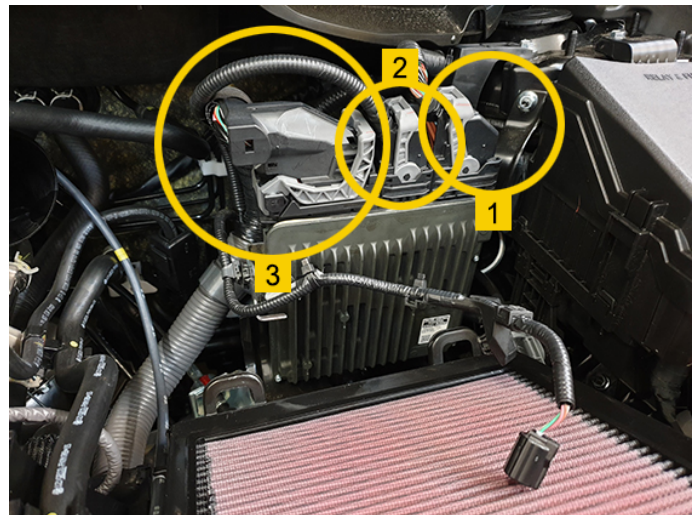

- Remove the highlighted nuts and bolts using the 10 mm socket, extension and ratchet.

Put them aside as they will be reused.

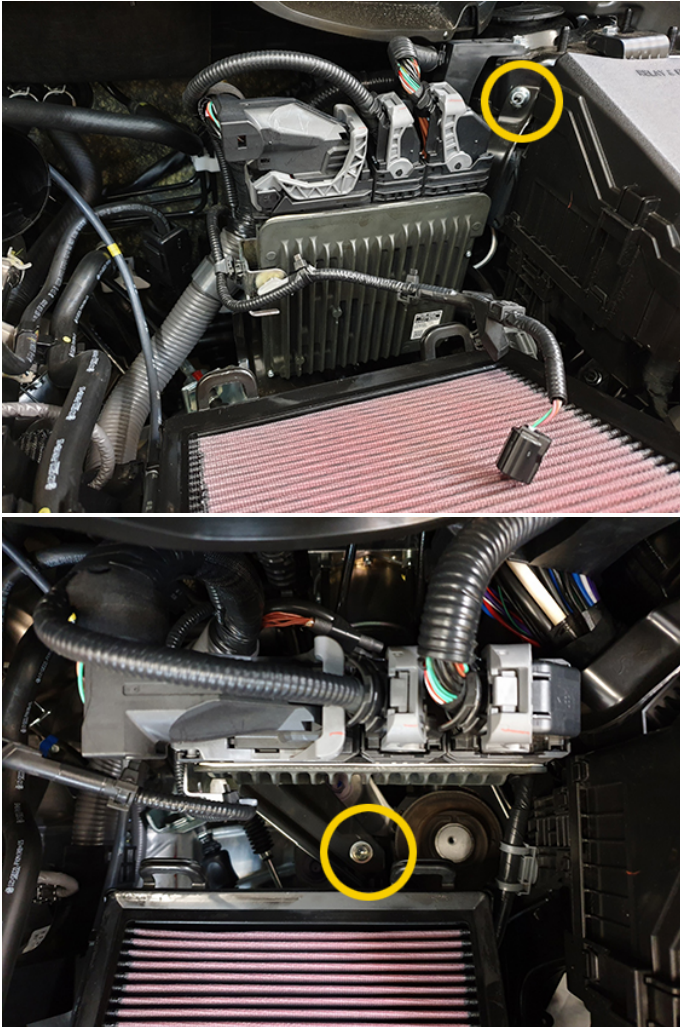

- Gently pull the ECU forward and towards the centre of the car to get the ECU bracket off the mounting stud on the strut tower.

- Remove the ECU wiring:
 - When the ECU is off the mounting stud, pull the top of the ECU forward to allow access to the wiring clips on the backside of the ECU.
 - Unclip the main loom branch. This allows tilting the ECU further forward.
 - Unclip the smaller wiring branch with pliers or a small flat blade screw driver.



- With the wiring removed, the ECU can carefully be removed from the engine bay.
- Put it in a work space. Remove the two black mounting brackets from the OE ECU by undoing the highlighted bolts.

Put them aside as they will be reused.

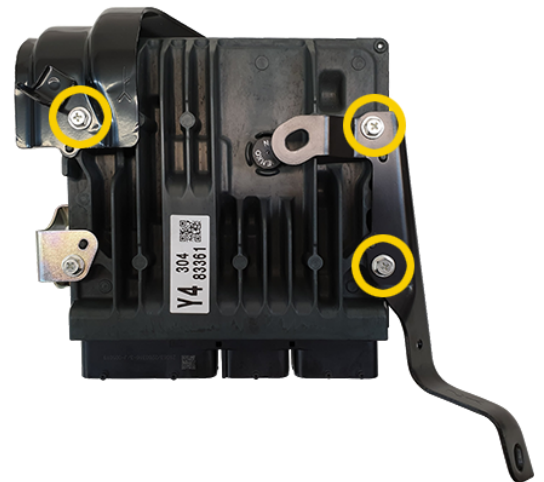

Step 3: Lambda sensor

- To remove the OE wideband Lambda sensor:
 - Fist unplug it. The connector is under the main loom (circled).

To locate the connector look for the black sleeved wire with a tape on it. It can be identified as it is secured in a wire frame.

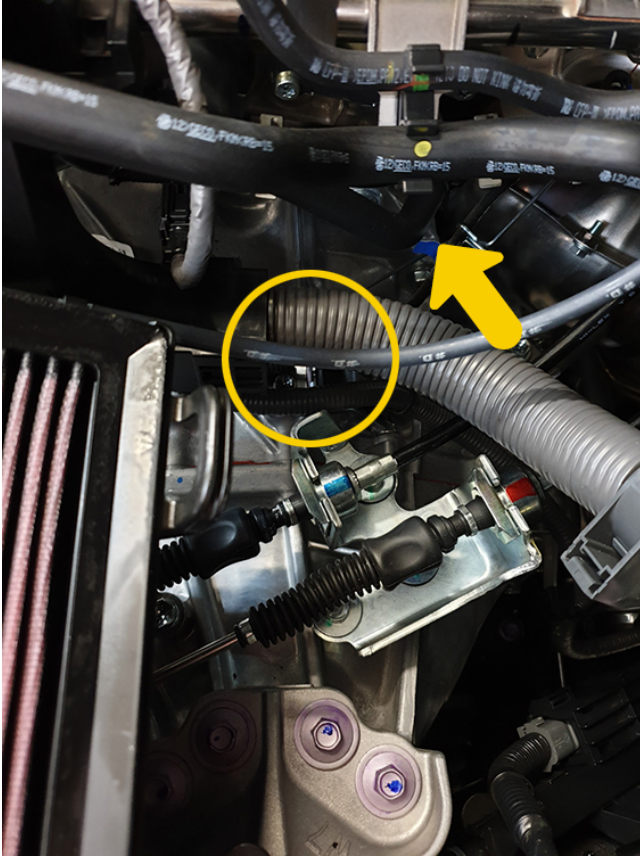

- Feed the 12 inch extension through the circled area. There is a small space between the head and plastic intake pipe to feed the extension through.

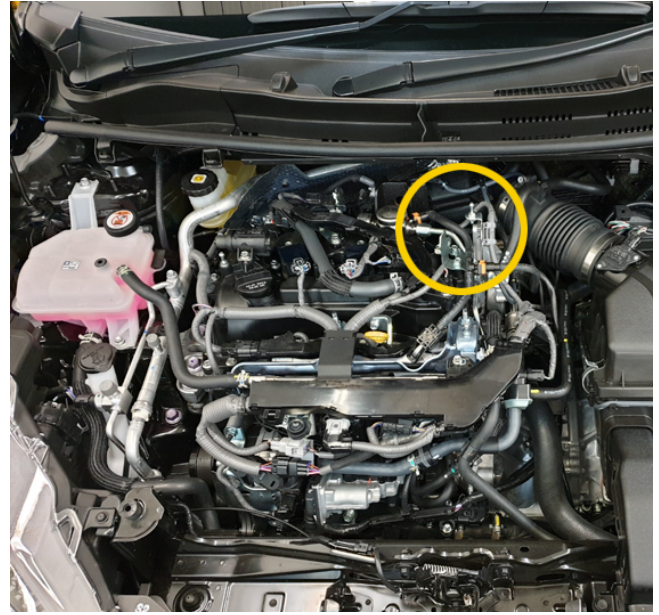

- Attach the extension to the universal joint.
- Loosen and remove the OE wideband Lambda sensor.
- Install and torque the supplied Bosch LSU 4.9 wideband sensor in the exhaust pipe where the OE sensor was fitted.
- Secure the wiring to the wire frame.

- With the sensor wiring unhooked, fit a Lambda sensor socket onto the sensor, as well as a universal joint.

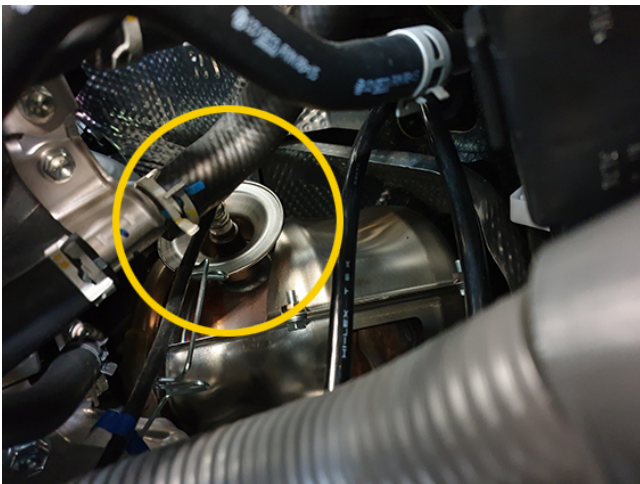

Step 4: Install MoTeC Kit

- Attach the MoTeC ECU to the Yaris GR adapter box with the three supplied M5 fasteners.



- Fit the supplied stub looms between the MoTeC ECU and the Yaris GR adapter box.
 - Start with the centre two, before fitting the outer two.



- When fitting the stub loom with the Ethernet communications cable, plug the end with the Ethernet cable into the MoTeC ECU (not the adapter box) This will provide communication with the ECU when installed.



- Drill out the hole (as marked) on the OE ECU bracket to 5 mm.



- Fit the reserved OE ECU brackets (see step 2) to the adapter assembly using the screws that were removed in step 2.

Fit the M5 washer in between the adaptor and the lower bracket (RH mounting hole in the following image). This is to ensure the mounting bracket clears the Breakout connector.

When fitting the bracket to the two holes pictured on the left, ensure the bracket has maximum clearance from the OE ECU header, as there is minimal clearance when plugging the adapter into the OE loom.

The adapter box does not have locating dowels. The lower bracket, held with the single screw can be adjusting after initial installation to align the assembly correctly.



- The assembly is now complete.



- Feed the assembly roughly into place.

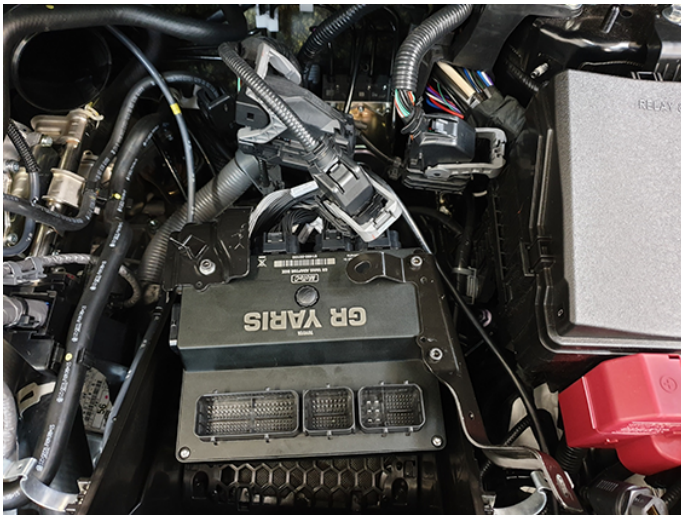

- Plug the OE connectors into the adapter box in the reverse procedure to their removal from the OE ECU (see step 2).

There will be insufficient space to do this once the ECU is bolted in place.

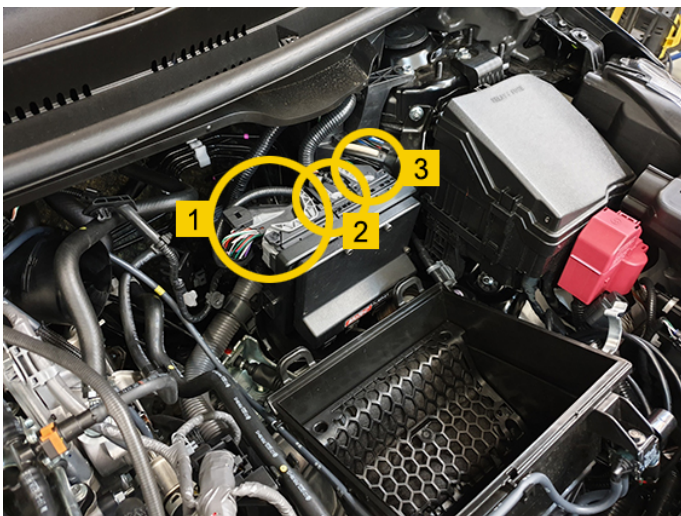

- Locate the brackets to bolt the unit in place.

Step 5: Finalise Installation

- Reroute the wiring for the mass airflow meter:
 - Remove the three plastic clips (third clip not shown in picture).

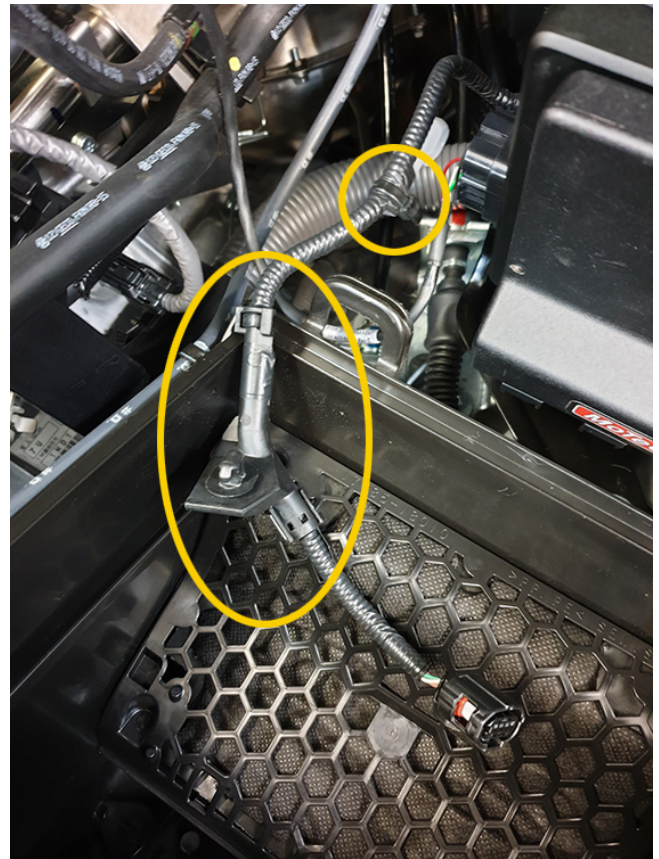

- Try to loosen or remove the third (unpictured) grey clip by lifting the zip tie locking tab and loosening. The wiring clip can be retained for securing the mass airflow wiring to the airbox.
- Feed the mass airflow wiring up behind the adapter box, passing it over the wiring connectors as pictured. Plug in the auxiliary adapter harness, then refit the air filter into the lower airbox.

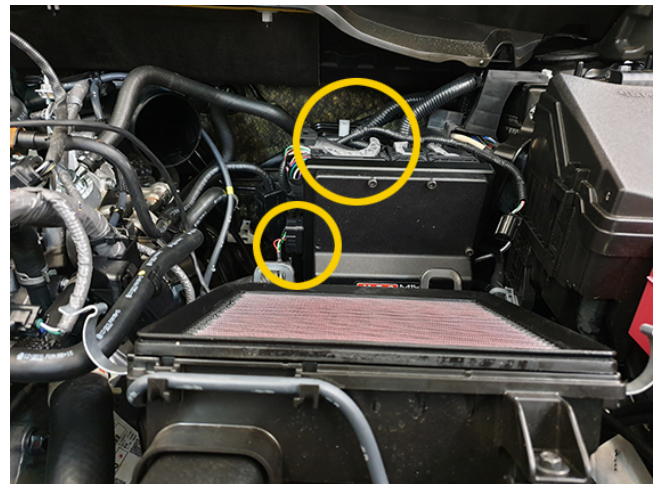

- Refit the upper airbox in the reverse method to the removal procedure.



- If the grey mass air flow wiring clip was successfully retained, fit it as shown to allow strain relief for the mass airflow wiring. Otherwise secure with a zip tie and the white mass airflow wiring clip.

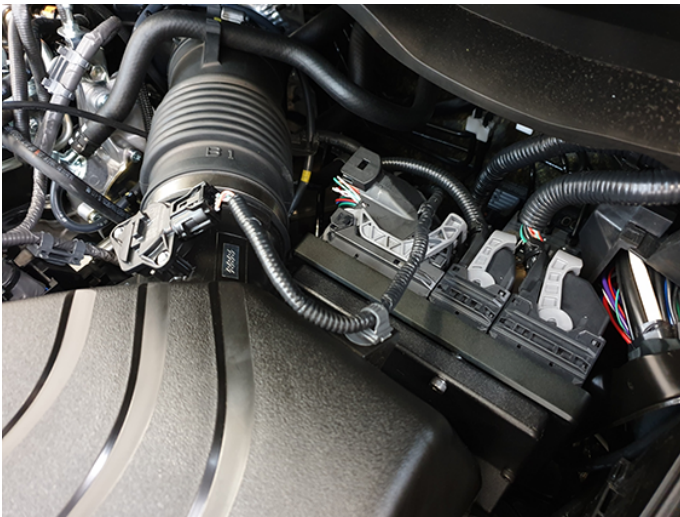

- Route the communications cable away from heat sources while remaining accessible.
- Connect the LTC to the LSU 4.9 sensor and 4 pin DTM on the auxiliary harness and secure the LTC.

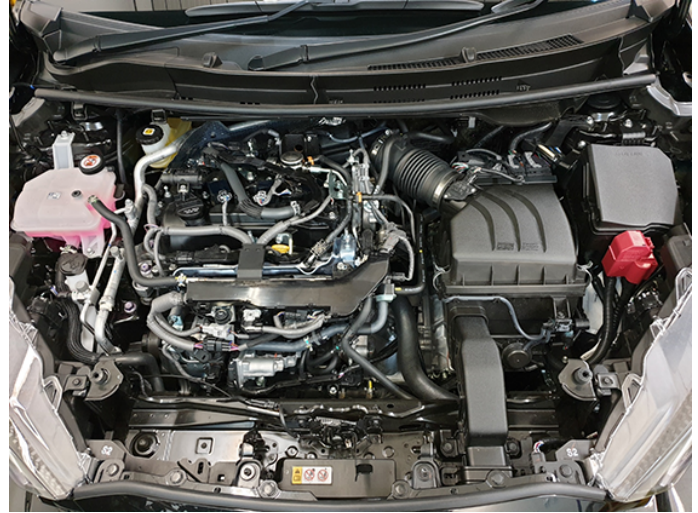

- Replace the engine cover to complete the installation.



Dash Override Installation

! Drivers should be aware that specifically the following standard features do not work utilising this M1 Package: Active Cruise Control, Dynamic Stability Control, Low Speed Pre-Collision System and Lane Trace Assist.

This Kit includes parts to install the optional Dash Override feature. This feature prevents alarms associated with these systems showing up on the dash,

Step 1: Remove Glovebox

- Open the glovebox, and remove any items from it.
- Next unclip the opening dampener (1) and remove the glovebox by pulling the glovebox up to unlatch the hinge, and then remove, moving each stopper (2) past the dashboard frame.

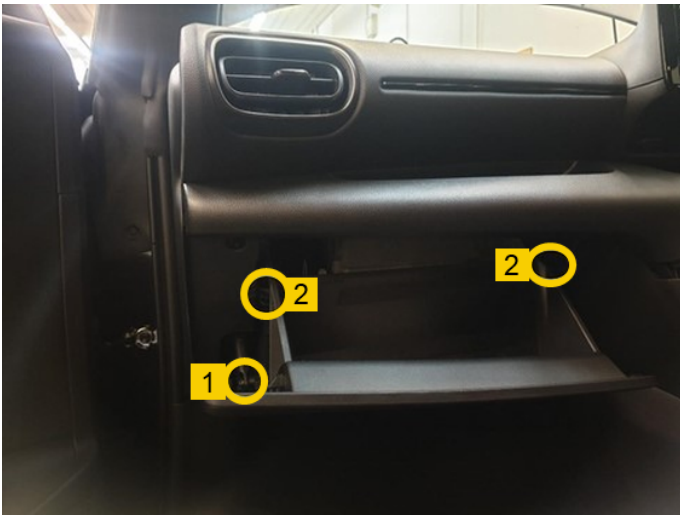

Step 2: CAN Wiring Modification

- The CAN gateway (circled) is located next to the HVAC unit. This is where the wiring modification is required. Ensure the car is powered off, and unplug this white connector.



- The CAN bus that needs to be intercepted is on pins 30 (red wire CAN HI) and 29 (white wire CAN LO).

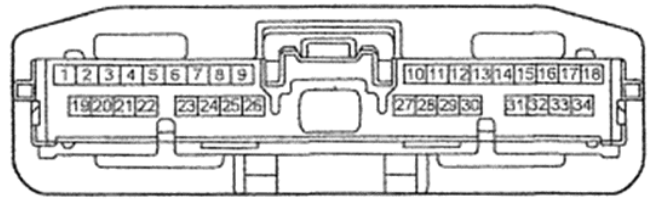

✦ Pin numbering is from the viewpoint of the pin side of the connector.

- Cut the CAN Hi (red) and CAN Lo (White) wires approx 100 mm from the gateway connector.

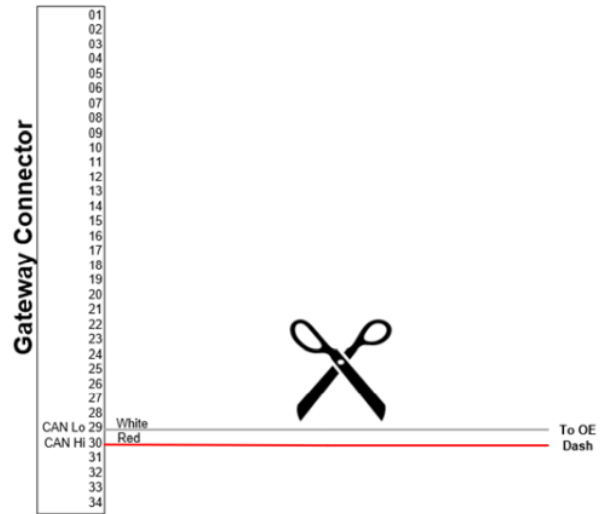

- Using the supplied DTM connectors, crimp and connect the wires as shown to the gateway loom.

The Adaptor Breakout Connector will be connected in step 4.

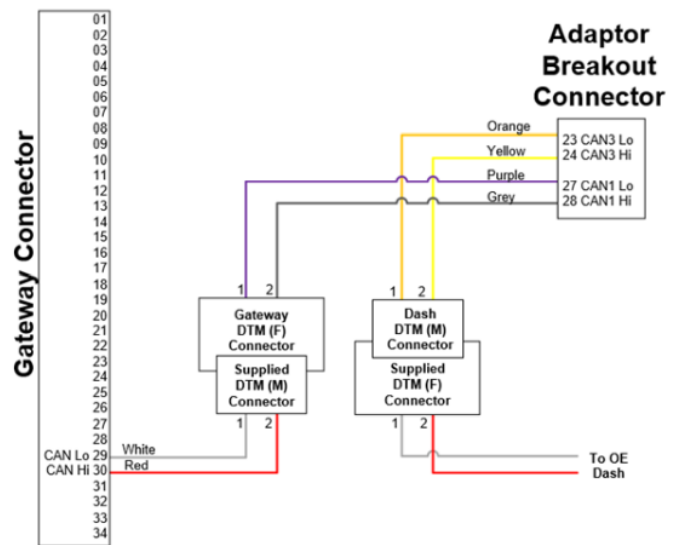

- Once this is joined, feed the wiring to the drivers side of the cabin, as the recommended grommet to pass the wiring through is above the steering column.

Step 3: Remove Wiper Components

- Now moving to the outside of the vehicle, the wiper cowl and plenum need to be removed. Start off by removing the two wiper arm bolt covers to expose the M10 nuts. Using a 14 mm socket and ratchet, remove the wiper arm, retaining the bolts.



- Once the wiper bolt is removed, remove the wiper arm by applying and releasing pressure with your palm in the area indicated by the arrow to disengage the taper fit. Use your other hand to support the wiper arm to prevent damaging any plastic trims when the wiper arm is disengaged.



- Remove the corner capping pieces from the wiper tray cover. This is done by prying up from the front corner with a plastic trim removal tool. Avoid using excessive force, as the trims are hooked under the front guards.



- The wiper tray cover can now be removed. The front edge clips into the sheetmetal lower cover with a series of clips. Unclip the front edge, then lift up and pull forward to remove the tray cover.



- Next the wiper motor assembly needs to be removed.
 - First undo the 2 x M6 bolts.
 - Then unclip the wiring harness from the motor (Item 2).
 - To remove the assembly, slide towards the centre of the vehicle approximately 30 mm and remove (Item 3).
 - Finally unclip the harness from the lower wiper cowl (Item 4)

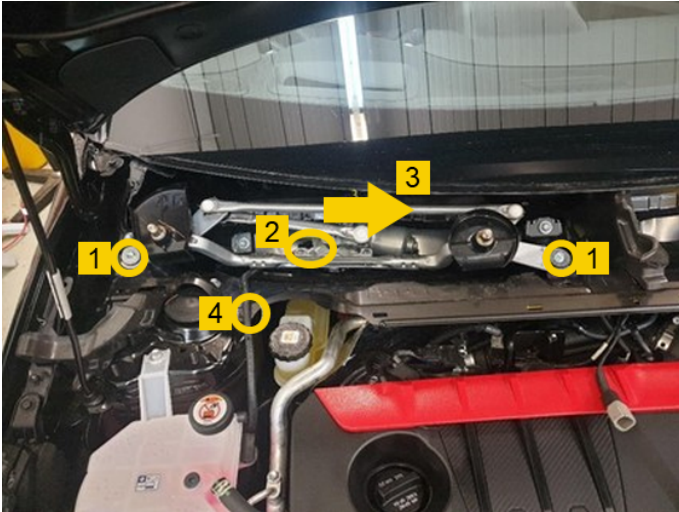

- Unbolt the lower wiper cowl by removing the 12 x M6 bolts. To do this, unclip the foam insert (indicated by the arrow). Once all the bolts are removed and the cowl is loose, lift slightly, and rotate the front edge towards the bonnet while pulling the cowl towards you to remove. Take care as some of the brackets on the firewall edge are quite flimsy and can potentially damage the front edge of the windscreen.



Step 4: Feed Loom Through Grommet

- Locate the driverside firewall grommet. There is a black nipple on the side nearest the brake booster (circled). The tip of this nipple needs to be cut off, using the casting line as a guide. The dash loom will pass through this. To aid in getting the wiring through this hole, feed a pull aid through from the engine bay side (a piece of welding filler rod, or a piece of wire are easiest).



- From inside the driver's footwell area, secure your gateway loom to your pull aid. The CAN wires need to be secured to the pull aid, and then pull the wiring through the firewall grommet carefully, ensuring the loom does not get caught on anything or wrapped around any pedals. This is easiest with one person guiding the loom, whilst another person pulls it through. (note in the image, the gateway loom has already been pulled through)



- We recommend using a few layers of glue lined heat shrink to build up a thick section that seals in this grommet nipple.
- Put a zip tie around the grommet to secure it.



- Connect the 4 terminated breakout loom wires to the Adaptor Breakout Connector as shown. See also loom schematic

Adaptor Breakout Connector

Orange	23 CAN3 Lo
Yellow	24 CAN3 Hi
Purple	27 CAN1 Lo
Grey	28 CAN1 Hi

- Secure the gateway loom along the factory harness and connect the breakout connector to the adaptor box.



Step 5: Setup

- Power on the vehicle
- Open **M1 Tune** and connect to the ECU
 - Set **CAN Bus 1, 2 and 3 Mode** to 500 kbps
 - Set **Exhaust Lambda Bank 1 Collector CAN Bus** to CAN Bus 2
 - Set **Toyota Yaris CAN Bus** to CAN Bus 2
 - Set **Toyota Yaris Dash Warning Override Dash CAN Bus** to CAN Bus 3
 - Set **Toyota Yaris Dash Warning Override Gateway CAN Bus** to CAN Bus 1

▶ **M142 ECU AND BREAKOUT PINOUT****M142 Connector A - 34 Way**

Mating Connector: Tyco Superseal 34 Position Keying 2 – MoTeC #65067

Pin	Designation	Full Name	OE or Breakout Pin	Description
A01	AT5	Analogue Temperature Input 5	Breakout 15	
A02	AT6	Analogue Temperature Input 6	B99	Intake Manifold Temperature Sensor
A03	AV15	Analogue Voltage Input 15	A52	Clutch Position
A04	AV16	Analogue Voltage Input 16	A58	Throttle Pedal Sensor Tracking
A05	AV17	Analogue Voltage Input 17	A55	Throttle Pedal Sensor Main
A06	INJ_D1A_NEG	Direct Injector 1A -		Not used - DO NOT CONNECT
A07	INJ_D1A_POS	Direct Injector 1A +		Not used - DO NOT CONNECT
A08	INJ_D1B_POS	Direct Injector 1B +		Not used - DO NOT CONNECT
A09	INJ_D1B_NEG	Direct Injector 1B -		Not used - DO NOT CONNECT
A10	SEN_5V0_C1	Sensor 5.0V C	A43, A57, A60, B75, B77, B80, B82, B84, B88, B96, B109, B113, B116, B120, C48	Sensor 5 V Supply
A11	LA_NB1	Lambda Narrow Input 1		
A12	LA_NB2	Lambda Narrow Input 2		
A13	KNOCK3	Knock Input 3		
A14	KNOCK4	Knock Input 4		
A15	DIG2	Digital Input 2	A31	Drive Mode Sport Switch
A16	DIG3	Digital Input 3	A24	Drive Mode Track Switch
A17	DIG4	Digital Input 4	A42	Vehicle Speed Signal
A18	SEN_5V0_C2	Sensor 5.0V C		
A19	SEN_5V0_B2	Sensor 5.0V B		
A20	LIN	LIN Bus	B62	LIN Comms - LIN Command to Alternator
A21	RS232_RX	RS232 Receive	Breakout 16	Optional GPS Receive
A22	RS232_TX	RS232 Transmit		
A23	DIG1	Digital Input 1	A51	Drive Mode Normal Switch
A24	BAT_NEG3	Battery Negative	A10, A36, A54	Chassis Ground
A25	BAT_NEG4	Battery Negative	A10, A36, A54	Chassis Ground
A26	SEN_0V_C1	Sensor 0V C	A28, A40, A44, A56, A59, B73, B76, B78, B79, B81, B83, B89, B110, B114, B115, B119, B126, B130, C47	Sensor 0V Supply
A27	SEN_0V_C2	Sensor 0V C		
A28	CAN3_HI	CAN Bus 3 High	Breakout 24	
A29	CAN3_LO	CAN Bus 3 Low	Breakout 23	
A30	CAN2_HI	CAN Bus 2 High	A8, Breakout 33	Vehicle 500 Kbit/sec CAN
A31	CAN2_LO	CAN Bus 2 Low	A18, Breakout 32	Vehicle 500 Kbit/sec CAN
A32	BAT_NEG5	Battery Negative	A10, A36, A54	Chassis Ground
A33	SEN_0V_B1	Sensor 0V B		
A34	SEN_0V_A1	Sensor 0V A		

M142 Connector B - 26 Way

Mating Connector: Tyco Superseal 26 Position Keying 3 – MoTeC #65068

Pin	Designation	Full Name	OE or Breakout Pin	Description
B01	OUT_HB9	Half Bridge Output 9	A16	Tachometer Output
B02	OUT_HB10	Half Bridge Output 10	A6	Fuel Pressure Control Pump Output (low pressure pump)
B03	UDIG8	Universal Digital Input 8	A39	Key In Lock signal
B04	UDIG9	Universal Digital Input 9	A22	Brake Switch
B05	UDIG10	Universal Digital Input 10	A23	Clutch Switch
B06	UDIG11	Universal Digital Input 11	C54	Transmission Speed Sensor
B07	UDIG12	Universal Digital Input 12	B65	Gear Reverse Switch
B08	INJ_LS5	Low Side Injector 5	B45	Fuel Purge Solenoid
B09	INJ_LS3	Low Side Injector 3	B50	Port Injector Cylinder 3
B10	AV9	Analogue Voltage Input 9	A27	Cruise Control Stalk
B11	AV10	Analogue Voltage Input 10	B101	Engine Oil Temperature Sensor
B12	AV11	Analogue Voltage Input 11	C37	OPF Differential Pressure Signal
B13	BAT_POS	Battery Positive	A9, A35, B18, B19, B21, B25, B27, B38, C53	Switched Battery Supply
B14	INJ_LS6	Low Side Injector 6	B20	Turbocharger Bypass Actuator Output
B15	INJ_LS4	Low Side Injector 4	B49	Airbox Flap Actuator Output
B16	AV12	Analogue Voltage Input 12	Breakout 14	
B17	AV13	Analogue Voltage Input 13	Breakout 12	
B18	AV14	Analogue Voltage Input 14	Breakout 13	
B19	BAT_POS	Battery Positive	A9, A35, B18, B19, B21, B25, B27, B38, C53	Switched Battery Supply
B20	OUT_HB7	Half Bridge Output 7	A30	Starter Relay
B21	OUT_HB8	Half Bridge Output 8	B22	Boost Solenoid Normal Output
B22	INJ_D2A_NEG	Direct Injector 2A -	B12	Fuel Cylinder 1 Primary -
B23	INJ_D2A_POS	Direct Injector 2A +	B31	Fuel Cylinder 1 Primary +
B24	INJ_D2B_POS	Direct Injector 2B +		Not used - DO NOT CONNECT
B25	INJ_D2B_NEG	Direct Injector 2B -		Not used - DO NOT CONNECT
B26	SEN_5V0_A	Sensor 5.0V A		

M142 Connector C - 34 Way

Mating Connector: Tyco Superseal 34 Position Keying 1 – MoTeC #65044

Pin	Designation	Full Name	OE or Breakout Pin	Description
C01	OUT_HB2	Half Bridge Output 2	B4	Throttle Servo Bank 1 Motor +
C02	SEN_5V0_A	Sensor 5.0V A	Breakout 4, 5, 6, 7	Sensor 5V Supply
C03	IGN_LS1	Low Side Ignition 1	A15	Main Relay
C04	IGN_LS2	Low Side Ignition 2	A34	ECU Relay
C05	IGN_LS3	Low Side Ignition 3	A32	Coolant Fan 1 Output
C06	IGN_LS4	Low Side Ignition 4	B71	Ignition Cylinder 2
C07	IGN_LS5	Low Side Ignition 5	B72	Ignition Cylinder 1
C08	IGN_LS6	Low Side Ignition 6	B70	Ignition Cylinder 3
C09	SEN_5V0_B	Sensor 5.0V B		
C10	BAT_NEG1	Battery Negative	A10, A36, A54	Chassis Ground
C11	BAT_NEG2	Battery Negative	A10, A36, A54	Chassis Ground
C12	IGN_LS7	Low Side Ignition 7		
C13	IGN_LS8	Low Side Ignition 8		
C14	AV1	Analogue Voltage Input 1	B105	Boost Pressure Sensor #1
C15	AV2	Analogue Voltage Input 2	B103	Turbo Pressure Sensor #2
C16	AV3	Analogue Voltage Input 3	B100	Oil Pressure Sensor
C17	AV4	Analogue Voltage Input 4	B98	Intake Manifold Pressure Sensor
C18	OUT_HB1	Half Bridge Output 1	B3	Throttle Servo Bank 1 Motor -
C19	INJ_D3A_POS	Direct Injector 3A +	B35	Fuel Cylinder 3 Primary +
C20	INJ_D3B_POS	Direct Injector 3B +		Not used - DO NOT CONNECT
C21	INJ_D4A_POS	Direct Injector 4A +	B33	Fuel Cylinder 2 Primary +
C22	INJ_D4B_POS	Direct Injector 4B +		Not used - DO NOT CONNECT
C23	INJ_LS1	Low Side Injector 1	B52	Port Injector Cylinder 1
C24	INJ_LS2	Low Side Injector 2	B51	Port Injector Cylinder 2
C25	AV5	Analogue Voltage Input 5	B121	Fuel Pressure Sensor (Lift/Port Injector Pressure)
C26	BAT_POS	Battery Positive	A9, A35, B18, B19, B21, B25, B27, B38, C53	Switched Battery Supply
C27	INJ_D3A_NEG	Direct Injector 3A -	B16	Fuel Cylinder 3 Primary -
C28	INJ_D3B_NEG	Direct Injector 3B -		Not used - DO NOT CONNECT
C29	INJ_D4A_NEG	Direct Injector 4A -	B14	Fuel Cylinder 2 Primary -
C30	INJ_D4B_NEG	Direct Injector 4B -		Not used - DO NOT CONNECT
C31	OUT_HB3	Half Bridge Output 3	B10	Fuel Pressure Direct Pump -
C32	OUT_HB4	Half Bridge Output 4	B29	Fuel Pressure Direct Pump +
C33	OUT_HB5	Half Bridge Output 5	B28	Intake Camshaft Position Actuator
C34	OUT_HB6	Half Bridge Output 6	B26	Exhaust Camshaft Position Actuator

M142 Connector D - 26 Way

Mating Connector: Tyco Superseal 26 Position Keying 1 – MoTeC #65045

Pin	Designation	Full Name	OE or Breakout Pin	Description
D01	UDIG1	Universal Digital Input 1	B92	Engine Speed (Crank) Sensor
D02	UDIG2	Universal Digital Input 2	B90	Inlet Camshaft Bank 1 Position
D03	AT1	Analogue Temperature Input 1	B102	Boost #2 Temperature Sensor
D04	AT2	Analogue Temperature Input 2	B104	Transmission Temperature Sensor
D05	AT3	Analogue Temperature Input 3	B106	Inlet Air Temperature Sensor
D06	AT4	Analogue Temperature Input 4	B129	Coolant Temperature Sensor
D07	KNOCK1	Knock Input 1	B111	Knock Sensor
D08	UDIG3	Universal Digital Input 3	B91	Exhaust Camshaft Bank 1 Position
D09	UDIG4	Universal Digital Input 4	A21	Brake Switch
D10	UDIG5	Universal Digital Input 5	B107	Airbox Mass Flow signal
D11	UDIG6	Universal Digital Input 6	A4, Breakout 19	iMT Switch
D12	BAT_BAK	Battery Backup	A1	Permanent Power
D13	KNOCK2	Knock Input 2	B112	Knock Sensor
D14	UDIG7	Universal Digital Input 7	A13	Ignition Switch Sense
D15	SEN_0V_A	Sensor 0V A	Breakout 20, 21, 22, 29, 30, 31	Sensor 0V Supply
D16	SEN_0V_B	Sensor 0V B		
D17	CAN1_HI	CAN Bus 1 High	Breakout 28	MoTeC 1 Mbit/sec CAN
D18	CAN1_LO	CAN Bus 1 Low	Breakout 27	MoTeC 1 Mbit/sec CAN
D19	SEN_6V3	Sensor 6.3V	Breakout 3	
D20	AV6	Analogue Voltage Input 6	B108	Throttle Servo Position Main
D21	AV7	Analogue Voltage Input 7	B87	Throttle Servo Position Tracking
D22	AV8	Analogue Voltage Input 8	B97	Fuel Pressure Direct Bank 1 Sensor
D23	ETH_TX+	Ethernet Transmit+		
D24	ETH_TX-	Ethernet Transmit-		
D25	ETH_RX+	Ethernet Receive+		
D26	ETH_RX-	Ethernet Receive-		

Breakout Connector E - 34 Way

Mating Connector: Tyco Superseal 34 Position Keying 2 (MoTeC #65044)

Pin	Designation	Full Name	M142 Pin	Function
E01	BAT_POS	Battery Positive	B13, B19, C26	LTC Power Supply
E02	BAT_POS	Battery Positive	B13, B19, C26	
E03	SEN_6V3	Sensor 6.3V	D19	Sensor 6.3V Supply
E04	SENS_5V0_A1	Sensor 5.0V A	C2	Sensor 5V Supply
E05	SENS_5V0_A1	Sensor 5.0V A	C2	Sensor 5V Supply
E06	SENS_5V0_A1	Sensor 5.0V A	C2	Sensor 5V Supply
E07	SENS_5V0_A1	Sensor 5.0V A	C2	Sensor 5V Supply
E08	BAT_NEG	Battery Negative	A24, A25, A32, C10, C11	
E09	BAT_NEG	Battery Negative	A24, A25, A32, C10, C11	LTC Power Ground
E10	BAT_POS	Battery Positive	B13, B19, C26	
E11				Not used
E12	AV13	Analogue Voltage Input 13	B17	
E13	AV14	Analogue Voltage Input 14	B18	
E14	AV12	Analogue Voltage Input 12	B16	
E15	AT5	Analogue Temperature Input 5	A1	
E16	RS232RX	RS232 Receive	A21	Usually for GPS.
E17	BAT_NEG	Battery Negative	A24, A25, A32, C10, C11	
E18				Not used
E19	UDIG6	Universal Digital Input 6	D11	iMT Switch
E20	SENS_0V_A1	Sensor 0V A	D15	Sensor 0V Supply
E21	SENS_0V_A1	Sensor 0V A	D15	Sensor 0V Supply
E22	SENS_0V_A1	Sensor 0V A	D15	Sensor 0V Supply
E23	CAN3LO	CAN Bus 3 Low	A29	Dash Override Low
E24	CAN3HI	CAN Bus 3 High	A28	Dash Override High
E25				Not used
E26				Not used
E27	CAN1LO	CAN Bus 1 Low	D18	Dash Override Low
E28	CAN1HI	CAN Bus 1 High	D17	Dash Override High
E29	SENS_0V_A1	Sensor 0V A	D15	Sensor 0V Supply
E30	SENS_0V_A1	Sensor 0V A	D15	Sensor 0V Supply
E31	SENS_0V_A1	Sensor 0V A	D15	Sensor 0V Supply
E32	CAN2LO	CAN Bus 2 Low	A31	OE Powertrain and LTC CAN Bus Low
E33	CAN2HI	CAN Bus 2 High	A30	OE Powertrain and LTC CAN Bus High
E34				Not used